

# PATS-GM2

Copyright © 2006-2007, FORTIN AUTO RADIO INC. ALL RIGHTS RESERVED

# INSTALLATION GUIDE

Made in Canada - Rev. X - 03 / 09 / 2008  
Web site: <http://www.ifar.ca>

## TRANSPONDER BYPASS FOR GM (NEW STYLE)



## WIRING / CONNECTION GUIDE

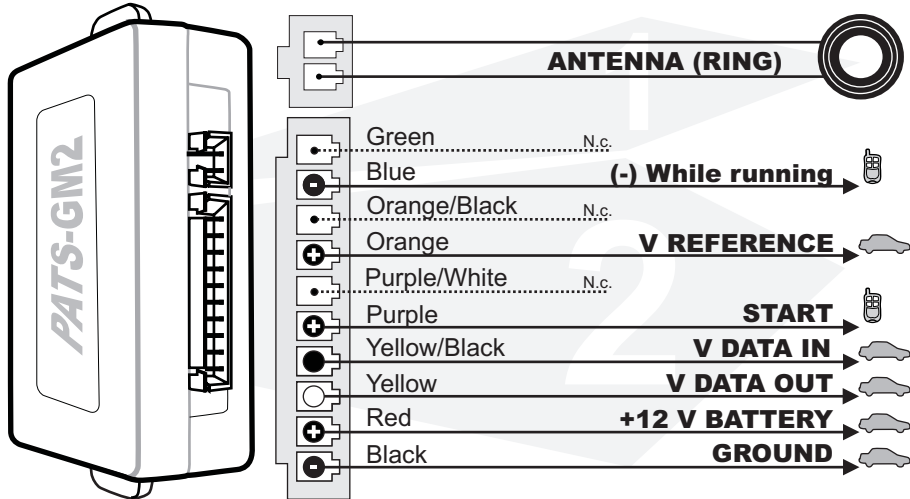

NOTE: Only one functional key is needed for programming.

### START HERE

## INSTALLATION INSTRUCTIONS

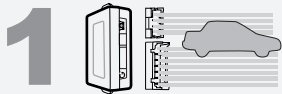

Make the connections of the **PATS-GM2** to the car.

Connector 1

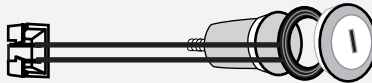

- ▶ Remove cap of the ignition barrel
- ▶ Stick the antenna to the ignition barrel.
- ▶ Replace the cap of the ignition barrel.

Connector 2



- ▶ See WIRING SCHEMATIC CONFIGURATION (P.4).

## PROGRAMMING PURSUIT AND COBALT

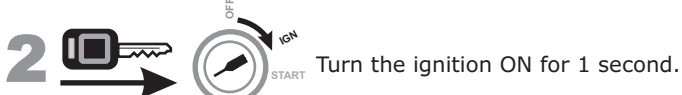

Turn the ignition ON for 1 second.



Remove the key.

You have 5 seconds to complete the following procedure

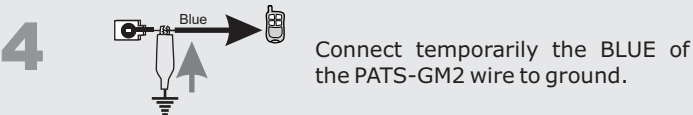

Connect temporarily the **BLUE** of the PATS-GM2 wire to ground.



Remove the blue wire from ground.

▶ If the security light turns OFF: **THE PATS-GM2 IS PROGRAMMED.**

▶ If the security light flashes: repeat step 2.

## PROGRAMMING OTHER VEHICLES

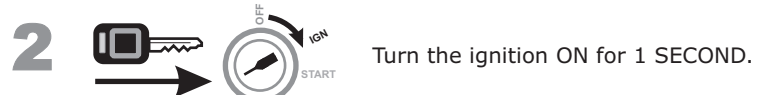

Turn the ignition ON for 1 SECOND.



Remove the key.

You have 5 seconds to complete the following procedure



Remote-Start the car.  
**THE PATS-GM2 IS PROGRAMMED.**

### IMPORTANT :

Once the **PATS-GM2** is programmed, it can not be programmed on another vehicle.

## TECHNICAL SUPPORT / INFORMATION

Neither the manufacturer or distributor of this module is responsible of damages of any kind indirectly or directly caused by this module, except for the replacement of this module in case of manufacturing defects. This module must be installed by qualified technician. This instruction guide may change without notice. Visit [www.ifar.ca](http://www.ifar.ca) to get latest version.

Technical support:  
TEL: 514-255-HELP (4357)  
FAX: 514-255-1367  
Web: [www.ifar.ca](http://www.ifar.ca)

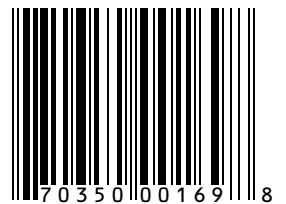

### CONTOURNEMENT DE TRANSPONDEUR POUR GM (NEW STYLE)



### CÂBLAGE / GUIDE DE CONNEXION

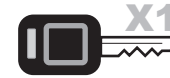
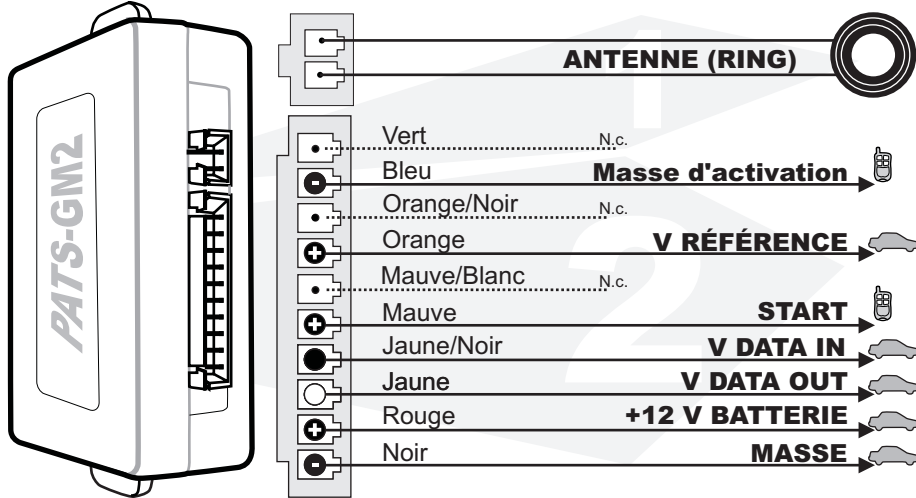

Note: Seule une clef fonctionnelle est nécessaire à la programmation.

**COMMENCEZ ICI**

### INSTRUCTION D'INSTALLATION

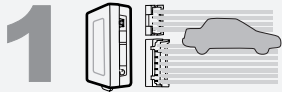

Effectuez les connexions du **PATS-GM2** au véhicule:

Connecteur no1

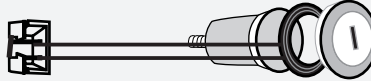

**Connecteur 1 (2 fils):**

- ▶ Retirez le capuchon du plastique du barillet d'ignition.
- ▶ Collez l'antenne (ring) autour du barillet d'ignition.
- ▶ Réinstallez le capuchon du barillet d'ignition.

Connecteur no2



**Connecteur 2 (10 fils):**

Voir le SCHÉMA DE BRANCHEMENT (P.3).

### PROGRAMMATION PURSUIT ET COBALT



Tournez la clef fonctionnelle à IGNITION pour 1 SECONDE.



Retirez la clef.

**VOUS AVEZ 4 SEC. POUR EFFECTUEZ L'ÉTAPE SUIVANTE:**

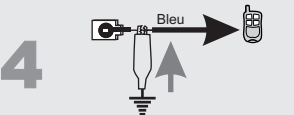

Connectez temporairement le fil BLEU du PATS-GM2 à la MASSE.

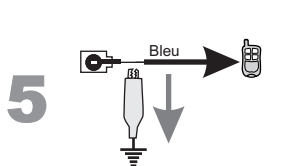

Déconnectez le fil bleu du PATS-GM2 de la masse.

▶ Si la lumière de sécurité du tableau de bord s'allume puis s'éteint: **Le PATS-GM2 EST PROGRAMMÉ.**

▶ Si la lumière de sécurité clignote recommencez à l'étape 2.

### PROGRAMMATION AUTRE VÉHICULES



Tournez la clef fonctionnelle à IGNITION pour 1 SECONDE.



Retirez la clef.

**VOUS AVEZ 4 SEC. POUR EFFECTUEZ L'ÉTAPE SUIVANTE:**



Démarrez le véhicule avec le démarreur à distance.  
**Le PATS-GM2 EST PROGRAMMÉ.**

**IMPORTANT:**

Une fois la puce du **PATS-GM2** programmée, elle ne peut être programmée ou utilisée sur un autre véhicule.

### INFORMATIONS / SUPPORT TECHNIQUE

Ni le fabricant, ni le distributeur ne se considèrent responsables des dommages causés ou ayant pu être causés, indirectement ou directement, par ce module, excepté le remplacement de ce module en cas de défectuosité de fabrication. Ce module doit être installé par un technicien qualifié. Ce guide d'instruction peut faire l'objet de changement sans préavis. Consultez le [www.ifar.ca](http://www.ifar.ca) pour voir la plus récente version.

**Support Technique:**  
TEL: 514-255-HELP (4357)  
FAX: 514-255-1367  
Web: [www.ifar.ca](http://www.ifar.ca)

## SCHÉMA DE BRANCHEMENT

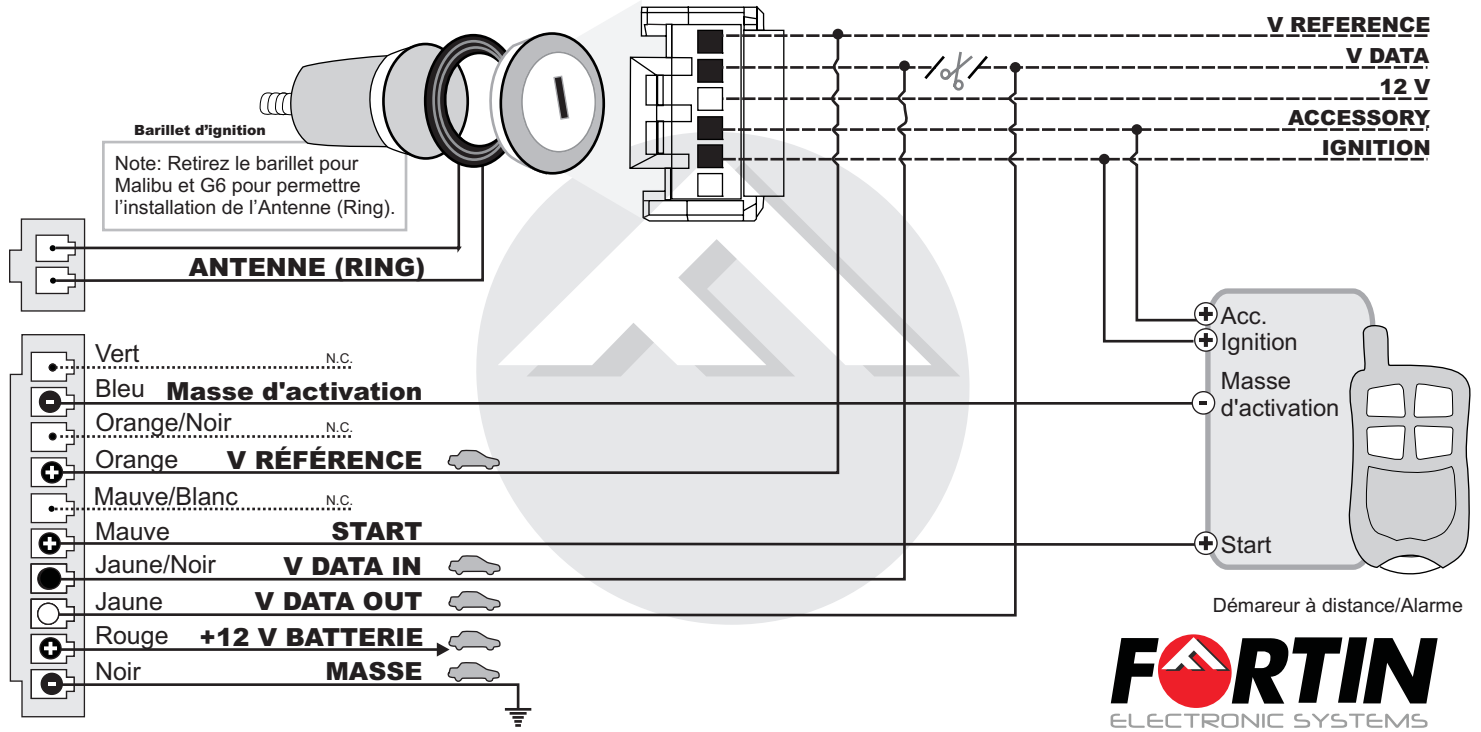

## GUIDE DES VOITURES

Véhicules	Années					Couleur des fils				
	04	05	06	07	08	09	V RÉFÉRENCE	V DATA	ACCESSOIRE	IGNITION
<b>Buick</b>										
Enclave							Blanc	Blanc/Noir	Brun	Rose
Lucerne							Blanc/Noir	Blanc	Brun	Rose
<b>Cadillac</b>										
CTS							Blanc/Noir	Blanc	Brun	Rose
DTS							Blanc/Noir	Blanc	Brun	Rose
Escalade							Blanc	Rose/Noir	Jaune	Rose
SRX							Blanc/Noir	Blanc	Brun	Rose
<b>Chevrolet</b>										
Avalanche							Blanc	Rose/Noir	Jaune	Rose
CK Pickup							Blanc	Rose/Noir	Jaune	Rose
Cobalt							Blanc/Noir	Blanc	Brun	Jaune
Equinox							Blanc	Blanc/Noir	Brun	Rose
Express							Blanc	Rose	Brun	Rose
HHR							Blanc/Noir	Blanc	Brun	Jaune
Impala							Blanc/Noir	Blanc	Brun	Rose
Malibu							Blanc/Noir	Blanc	Brun	Rose
Monte Carlo							Blanc/Noir	Blanc	Brun	Rose
Silverado							Blanc	Rose/Noir	Jaune	Rose
Suburban							Blanc	Rose/Noir	Jaune	Rose
Tahoe							Blanc	Rose/Noir	Jaune	Rose
<b>GMC</b>										
Acadia							Blanc/Noir	Blanc	Brun	Rose
Savana							Blanc	Rose	Brun	Rose
Sierra							Blanc	Rose/Noir	Jaune	Rose
Suburban							Blanc	Rose/Noir	Jaune	Rose
Yukon							Blanc	Rose/Noir	Jaune	Rose
<b>Hummer</b>										
H2							Blanc	Rose/Noir	Jaune	Rose
<b>Pontiac</b>										
G5							Blanc/Noir	Blanc	Brun	Rose
G6							Blanc/Noir	Blanc	Brun	Rose
G8							Blanc/Noir	Blanc	Brun	Rose
Pursuit							Blanc/Noir	Blanc	Brun	Jaune
Solstice							Blanc/Noir	Blanc	Brun	Jaune
Torrent							Blanc	Blanc/Noir	Brun	Rose
<b>Saturn</b>										
Aura							Blanc	Blanc/Noir	Brun	Rose
Outlook							Blanc/Noir	Blanc	Brun	Rose
Sky							Blanc/Noir	Blanc	Brun	Jaune
Vue							Blanc	Blanc/Noir	Jaune	Rose
<b>Suzuki</b>										
XL7							Blanc/Noir	Blanc	Brun	Rose

# PATS-GM2

Copyright © 2006-2007, FORTIN AUTO RADIO INC. ALL RIGHTS RESERVED

# INSTALLATION GUIDE

Made in Canada - Rev. X - 03 / 09 / 2008  
Web site: <http://www.ifar.ca>

## WIRING SCHEMATIC CONFIGURATION

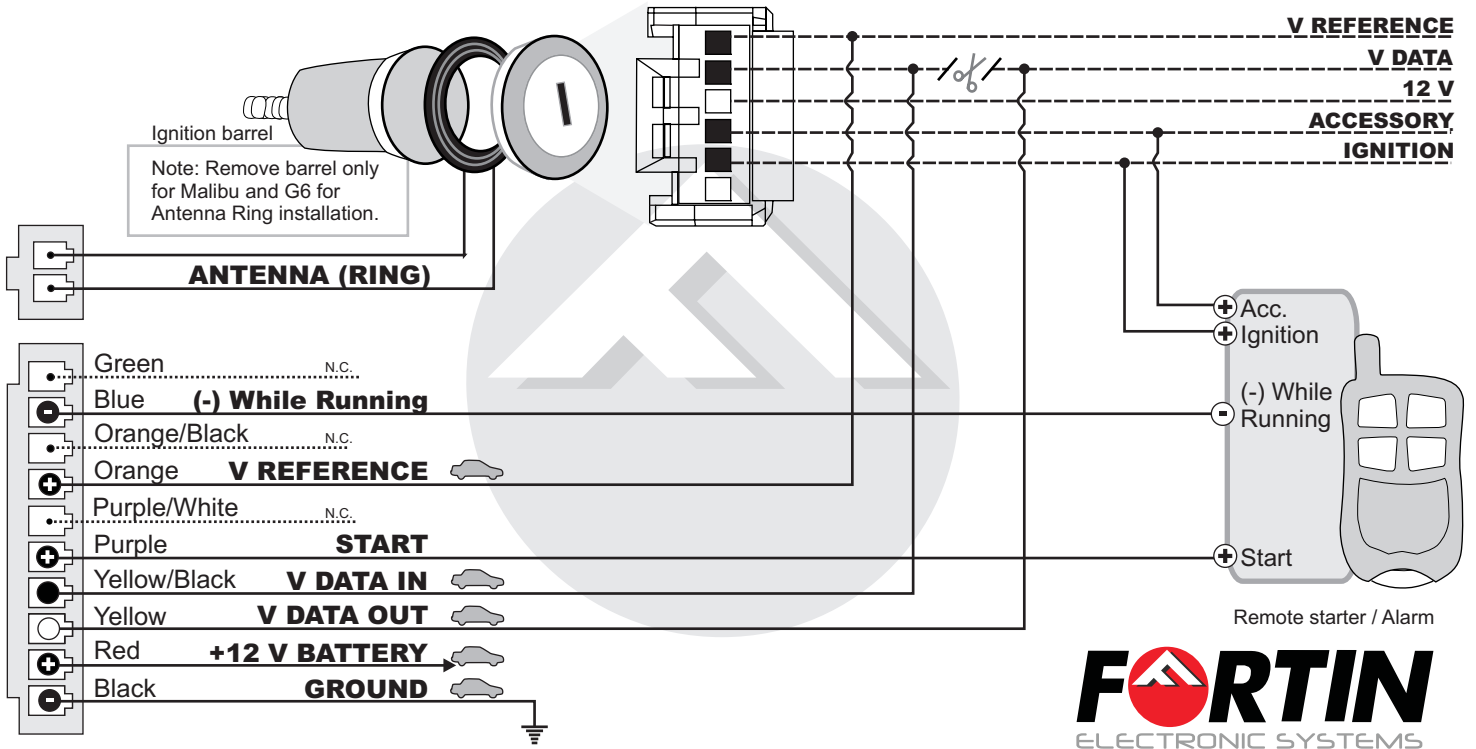

## VEHICLE FIT GUIDE

Vehicle	Years					Wire colors				
						V REFERENCE	V DATA	ACCESSOIRE	IGNITION	
<b>Buick</b>	04	05	06	07	08	09				
Enclave							White	White/Black	Brown	Pink
Lucerne							White/Black	White	Brown	Pink
<b>Cadillac</b>	04	05	06	07	08	09				
CTS							White/Black	White	Brown	Pink
DTS							White/Black	White	Brown	Pink
Escalade							White	Pink/Black	Yellow	Pink
SRX							White/Black	White	Brown	Pink
<b>Chevrolet</b>	04	05	06	07	08	09				
Avalanche							White	Pink/Black	Yellow	Pink
CK Pickup							White	Pink/Black	Yellow	Pink
Cobalt							White/Black	White	Brown	Yellow
Equinox							White	White/Black	Brown	Pink
Express							White	Pink	Brown	Pink
HHR							White/Black	White	Brown	Yellow
Impala							White/Black	White	Brown	Pink
Malibu							White/Black	White	Brown	Pink
Monte Carlo							White/Black	White	Brown	Pink
Silverado							White	Pink/Black	Yellow	Pink
Suburban							White	Pink/Black	Yellow	Pink
Tahoe							White	Pink/Black	Yellow	Pink
<b>GMC</b>	04	05	06	07	08	09				
Acadia							White/Black	White	Brown	Pink
Savana							White	Pink	Brown	Pink
Sierra							White	Pink/Black	Yellow	Pink
Suburban							White	Pink/Black	Yellow	Pink
Yukon							White	Pink/Black	Yellow	Pink
<b>Hummer</b>	04	05	06	07	08	09				
H2							White	Pink/Black	Yellow	Pink
<b>Pontiac</b>	04	05	06	07	08	09				
G5							White/Black	White	Brown	Pink
G6							White/Black	White	Brown	Pink
G8							White/Black	White	Brown	Pink
Pursuit							White/Black	White	Brown	Yellow
Solstice							White/Black	White	Brown	Yellow
Torrent							White	White/Black	Brown	Pink
<b>Saturn</b>	04	05	06	07	08	09				
Aura							White	White/Black	Brown	Pink
Outlook							White/Black	White	Brown	Pink
Sky							White/Black	White	Brown	Yellow
Vue							White	White/Black	Yellow	Pink
<b>Suzuki</b>	04	05	06	07	08	09				
XL7							White/Black	White	Brown	Pink